



KENT CNC

Multi-tasking

Turning Center

KENT CNC

Kent CNC, Division of Kent USA
1231 Edinger Avenue
Tustin, CA
USA 92780

Tel.: 1.800.KENT.USA | (714)258-8526
E-Mail: sales@kentusa.com
www.kentcnc.com



R01107

Copyright © 2014 Kent USA, Inc. All rights reserved.

Rigid Structure

**KLM-200S**

One-piece Slant Bed Structure

- The machine bed is made of one-piece high-grade Meehanite casting to allow heavy cutting capabilities. The wide hardened and ground box ways are coated with Turcite and hand-scraped for ultra-precise fitting to reduce vibration while offering better tool life and surface finishes.
- Each axis structure is directly driven by precision ballscrew and powered by AC servo motor for smooth slide movement with virtually no backlash.

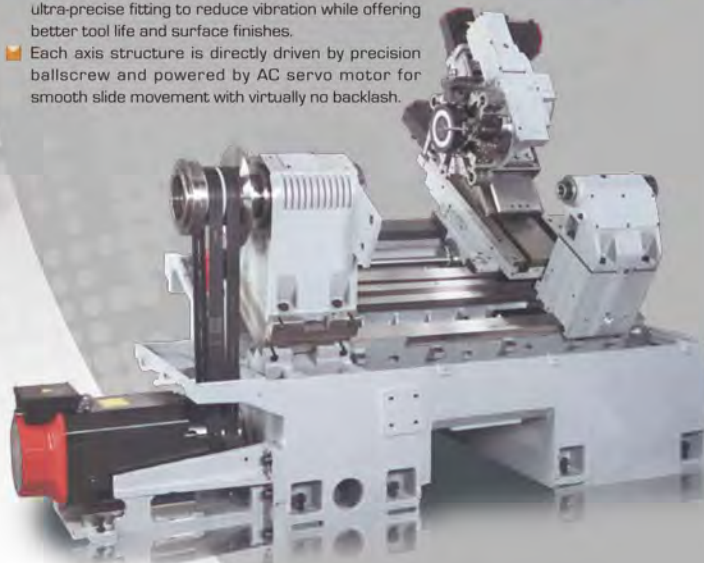
KLM-300Y

Multi-tasking Systems



Spindle

- The thermally symmetrical design on the head stock diminishes distortion and provides stable accuracy on work pieces even in continuous high speed machining. The spindle is supported by a double row of tapered roller bearings in the front and rear of the spindle to resist axial cutting force, while self-alignment angular contact bearings provide tremendous radial load capability.

Main and Sub Spindles Synchronization

- Available on both the main spindle and sub-spindles, C1 and C2 axes provide positioning resolution up to 0.015 degree to accomplish three dimensional contouring, combined round and prismatic machining by harmonized control of the spindles with the X and Z axes. Exact synchronization between the main spindle and sub spindle at any rotation speed can be programmed to perform part transfer for secondary machining to enhance production efficiency and reduces idle time.

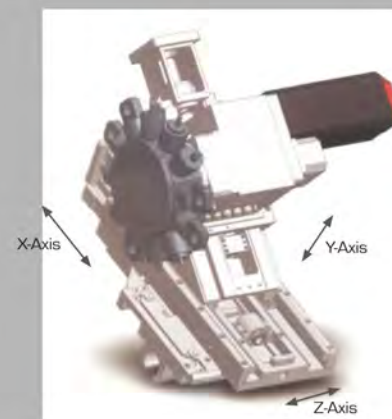
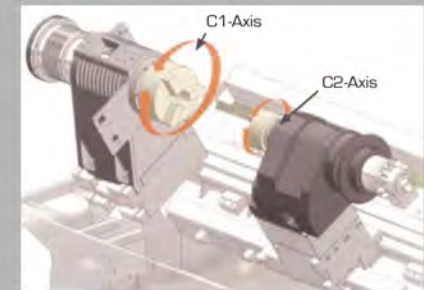

Y-axis

- Y-axis with +/- 50 mm of stroke is available for performing thread milling, complex off-center milling and drilling operations on the main or sub-spindle by combining live tool turret. The Yaxis travel is achieved by the simultaneous movement of the two independent slides. This design distributes cutting force over the two slides assuring exceptional rigidity and maximum accuracy.

Turning and Milling



VDI Power Turret

Turret

■ The fast 12-station servo-mechanical dodecagonal drum turret, featuring a large 3-piece curvic coupling and powerful hydraulic clamping force, assures unparalleled rigidity in all machining conditions. Live tool holders can be mounted on all 12 stations, but only the working position is driven. VDI live tool turret is also available as an option upon request.

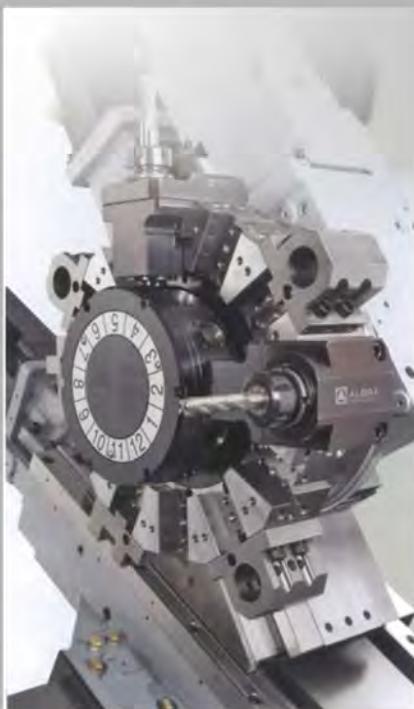

Power Turret



FANUC 18i-T controller

■ 10.4" color LCD plus manual guide i enable user to program complex components in multi-axis system.

Tooling System

KLM-200S/KLM-200SM

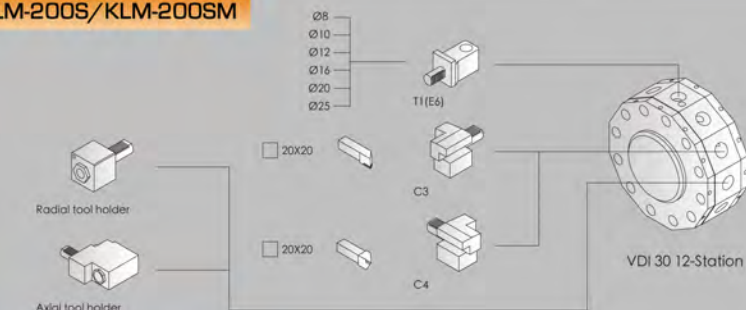

KLM-300Y/KLM-300LY

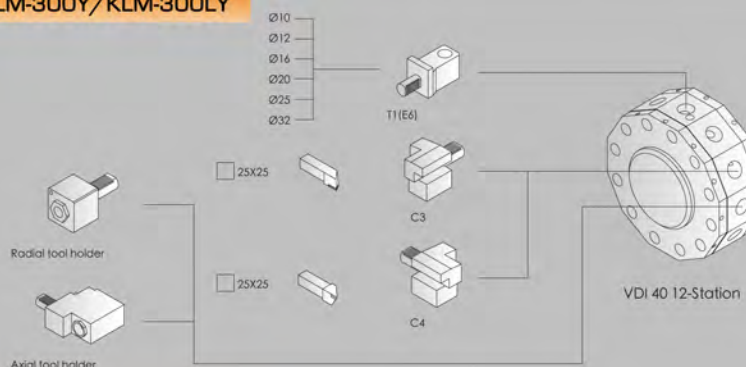

KLM-300Y/KLM-300LY

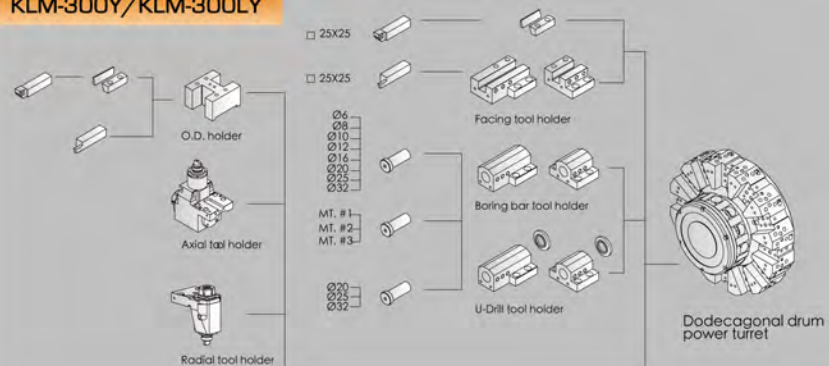

Working Range

KLM-200SM

VDI 30 12-station power turret

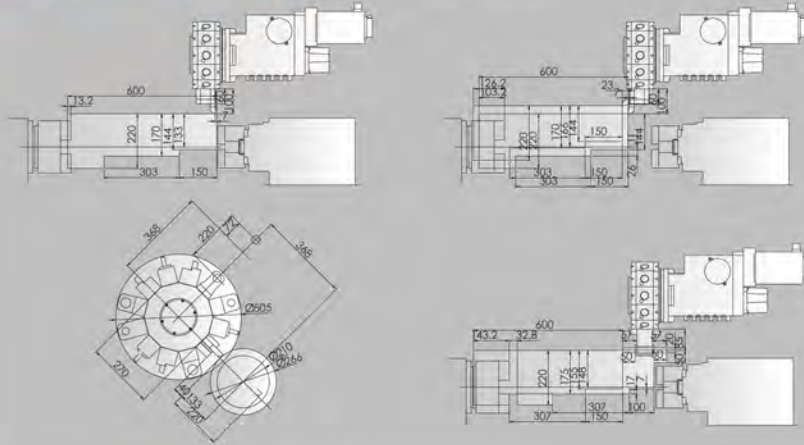

KLM-300SM

VDI 40 12-station power turret



KLM-300SM

power turret

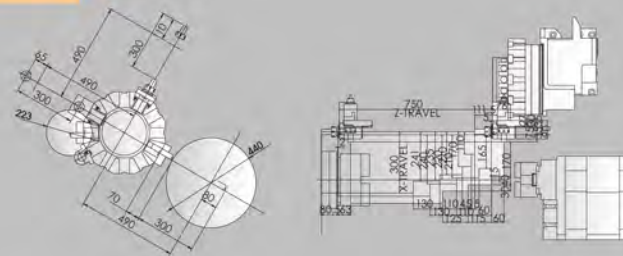

KLM-300Y/KLM-300LY

VDI 40 12-station power turret

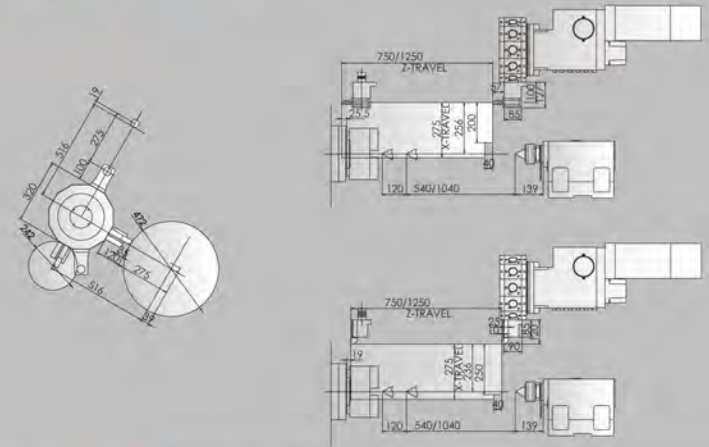

KLM-300Y/KLM-300LY

power turret

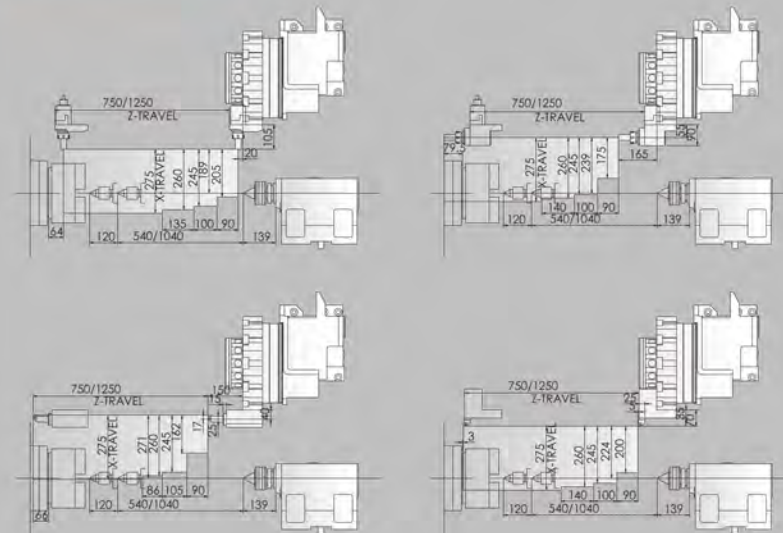

Working Range

KLM-300Y

VDI 40 12-station power turret

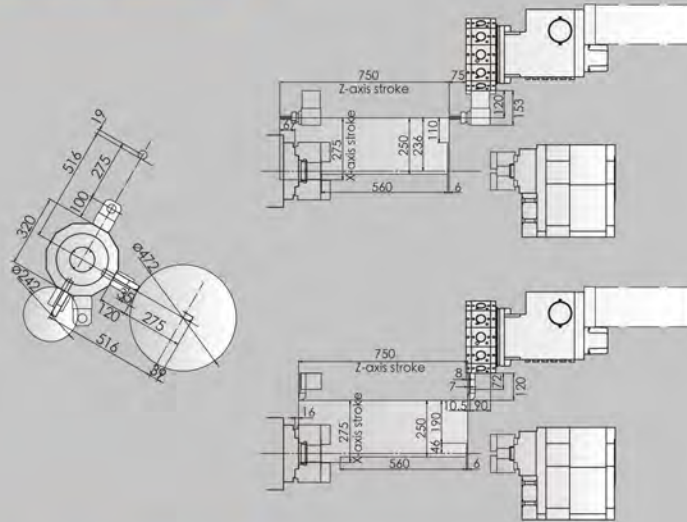

KLM-300SY

power turret

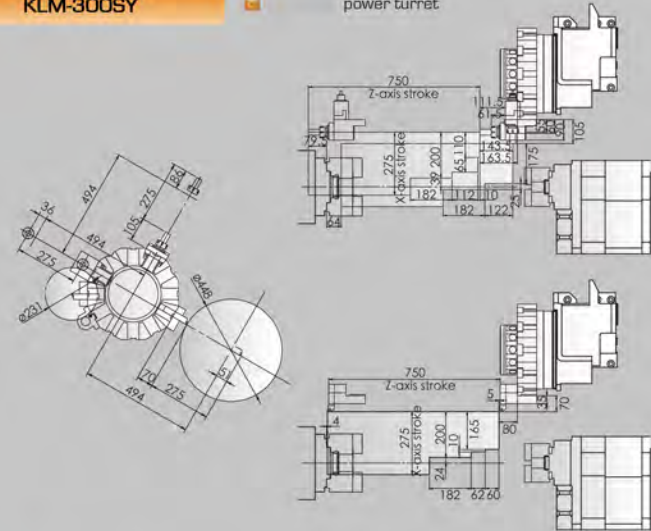

Spindle Torque Diagram

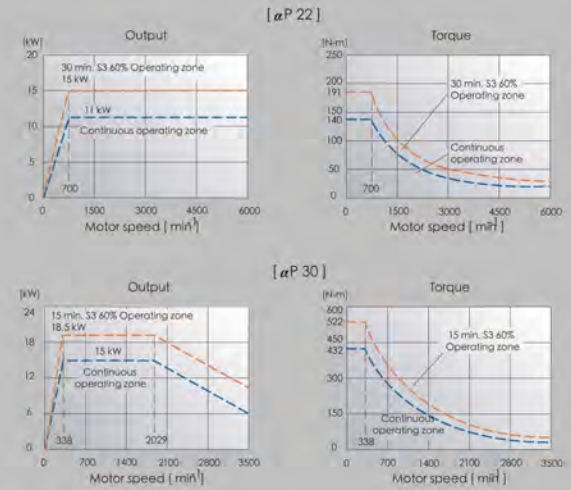

Machine Dimensions

KLM-200S/KLM-200SM

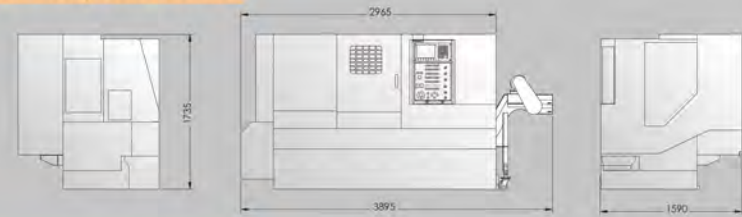

KLM-300Y/KLM-300LY

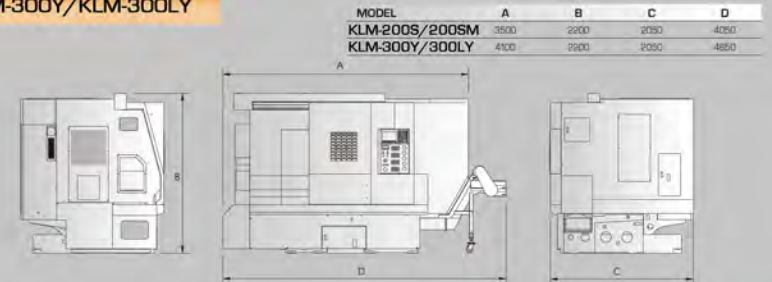

KLM-200 Specification

Machine Model	KLM-200S		KLM-200SM	
Controller	FANUC OiT		FANUC OiT	
CAPACITY				
Swing Over " Z" Cover	inch	21	21	
Swing Over " X" Cover	inch	13	13	
Max cutting diameter (Main spindle)	inch	10	11	
Max cutting diameter (Sub-spindle)	inch	10	11	
Max cutting length	inch	20	20	
MAIN SPINDLE				
Spindle Nose	ASA	A 2-6		A2-6
Spindle bearing inner diameter	inch	3.9	4.3	3.9 4.3
Power chuck diameter	inch	8		8
Spindle speed	rpm	4500	4000	4500 4000
Spindle drive power	hp	15/20		15/20
Bar capacity	inch	2	3	2 3
SUBSPINDLE				
Spindle Nose	ASA	A 2-5		A2-5
Power chuck diameter	inch	6		6
Spindle speed	rpm	6000		6000
Spindle drive power	hp	7/10		7/10
Bar capacity	inch	2		2
TRAVELS				
Z axis	inch	24		24
X axis	inch	9		9
B axis	inch	25		25
FEEDS				
Rapid traverse- Z axis	inch/min	79		79
Rapid traverse- X axis	inch/min	79		79
Rapid traverse- B axis	inch/min	79		79
TOOL TURRET				
Type		Hydraulic		Servo-mechanical
Number of tools	units	12 (VDI 30)		12 (VDI 30)
Tool size square (Machining the face)	inch	0.031		0.031
Tool size square (Machining the back)	inch	0.031		0.031
Tool size boring bar	inch	1.3		1.3
Cs spindle index angle	degree	-		0.015
Max. rotary tool speed	rpm	-		6000
Rotary tool driver power	hp	-		3
DIMENSIONS				
Floor space required	inch	114 x 63		114 x 63
Height	inch	67		67
Weight	lbs	8818		8818

KLM-300 Specification

Machine Model	KLM-300Y		KLM-300LY		KLM-300SM		KLM-300SY	
Controller	FANUC OiT		FANUC OiT		FANUC OiT		FANUC i18i	
CAPACITY								
Swing Over " Z" Cover	inch	36	36		24		36	
Swing Over " X" Cover	inch	28	28		15		28	
Max cutting diameter (Main spindle)	inch	19	19		17		18	
Max cutting diameter (Sub-spindle)	inch	-	-		15		15	
Max cutting length	inch	24	45		24		24	
MAIN SPINDLE								
Spindle Nose	ASA	A2-8		A2-8	A2-11	A2-8		A2-8
Spindle bearing inner diameter	inch	5.1	5.5	5.1	5.5	6.3	5.1	5.5
Power chuck diameter	inch	10	12	10	12	15	10	12
Spindle speed	rpm	3500	2700	3500	2700	2500	3500	2700
Spindle drive power	hp	20/25		20/25 (25/30)		20/25		20/25
Bar capacity	inch	3	3.5	3	3.5	4.1	3	3.5
SUBSPINDLE								
Spindle Nose	ASA	-		-		A2-5		A2-5
Power chuck diameter	inch	-		-		6		6
Spindle speed	rpm	-		-		6000		6000
Spindle drive power	hp	-		-		7/10		7/10
Bar capacity	inch	-		-		1.7		1.7
TRAVELS								
Z axis	inch	30		50		30		30
Y axis	inch	+/-2		+/-2		-		+/-2
X axis	inch	11		11		12		11
B axis	inch	-		-		28		28
FEEDS								
Rapid traverse- Z axis	inch/min	94		94		94		94
Rapid traverse- Y axis	inch/min	39		39		-		39
Rapid traverse- X axis	inch/min	79		79		79		79
Rapid traverse- B axis	inch/min	-		-		79		79
TOOL TURRET								
Type		APT / VDI		APT / VDI		APT / VDI		APT / VDI
Number of tools	units	12		12		12		12
Tool size square	inch	0.039		0.039		0.039		0.039
Tool size boring bar	inch	1.6		1.6		1.6		1.6
Cs spindle index angle	deg	0.015		0.015		0.015		0.015
Max. rotary tool speed	rpm	4000		4000		4000		4000
Rotary tool driver power	hp	4/5		4/5		4/5		4/5
TAILSTOCK								
Tailstock body travel	inch	21		41		-		-
Quill travel	inch	5		5		-		-
Quill diameter	inch	3		3		-		-
Quill taper hole	MT	5		5		-		-
Tailstock body positioning		Programmable		Programmable		-		-
DIMENSIONS								
Floor space required	inch	138 x 79		157 x 79		118 x 75		138 x 79
Height	inch	87		87		79		87
Weight	lbs	13,228		16,535		13,007		14,330